

**DETAIL OF MOUNTING BLOCK**

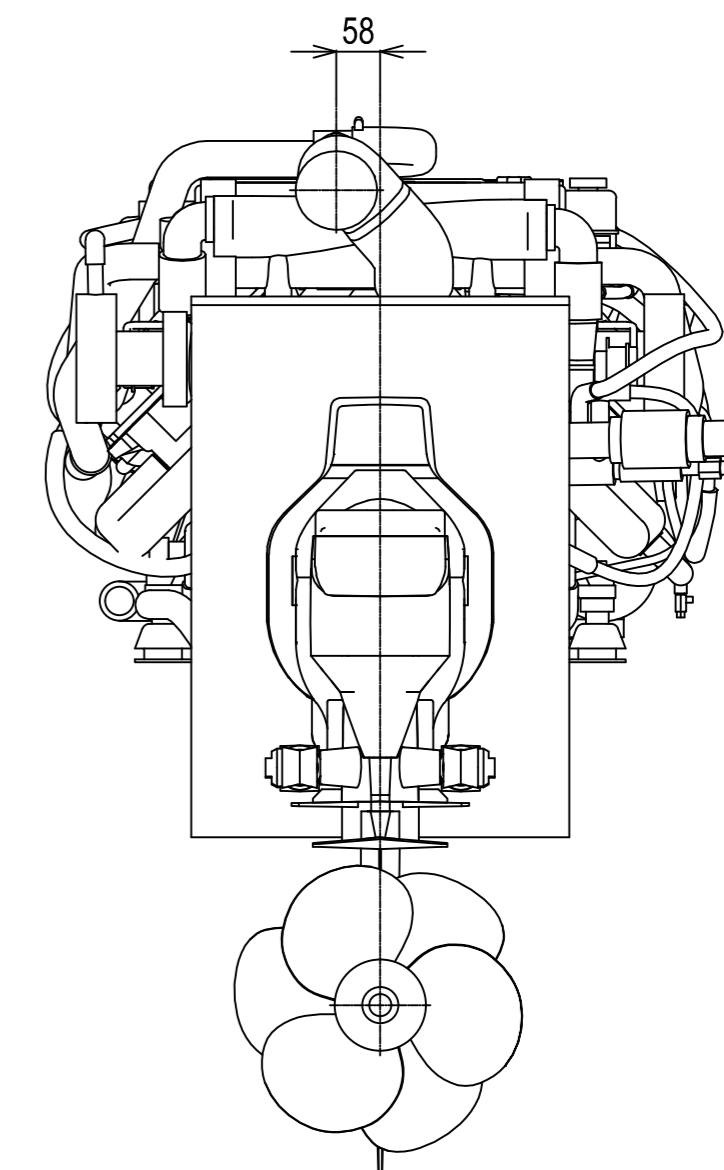
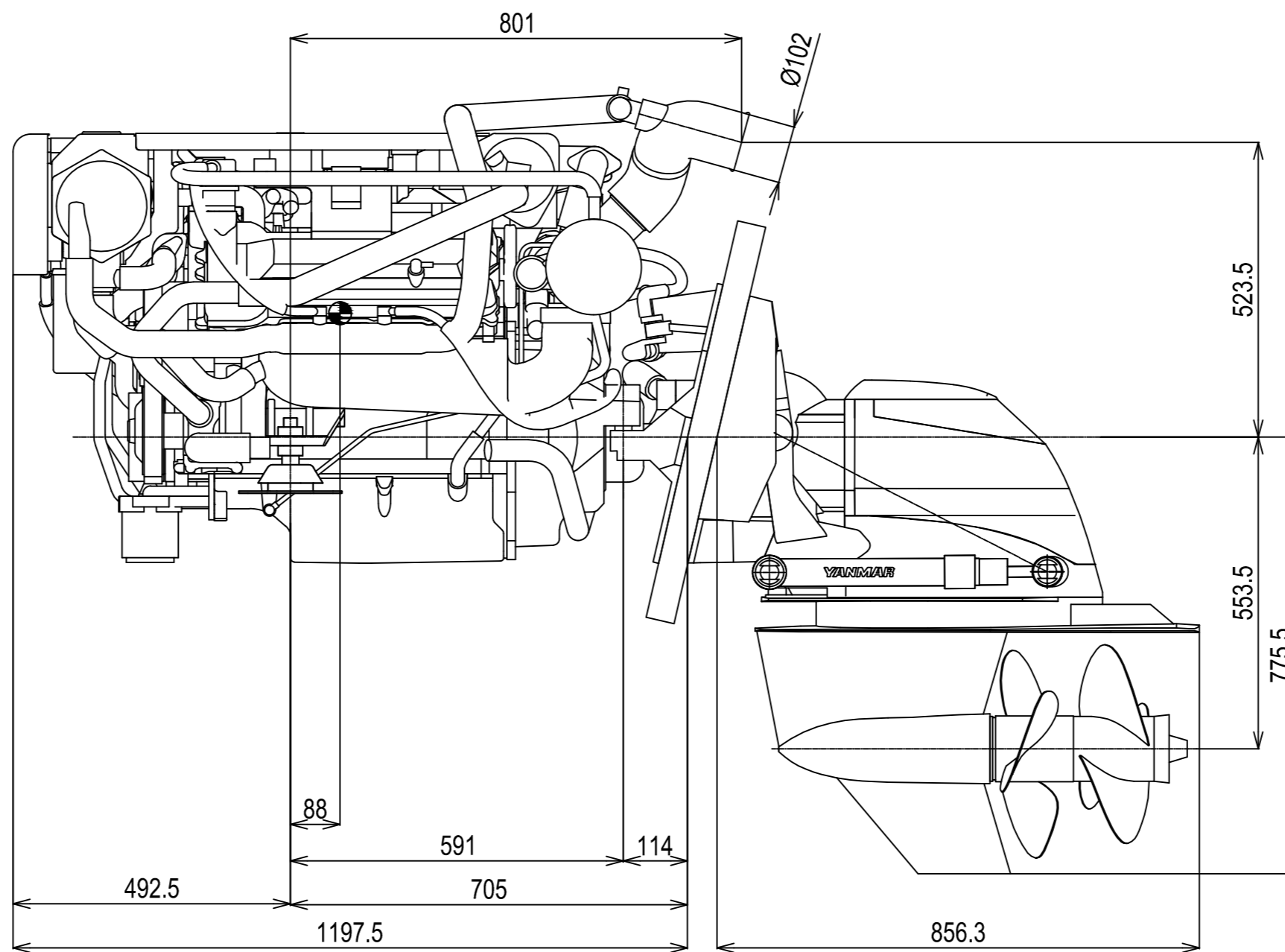
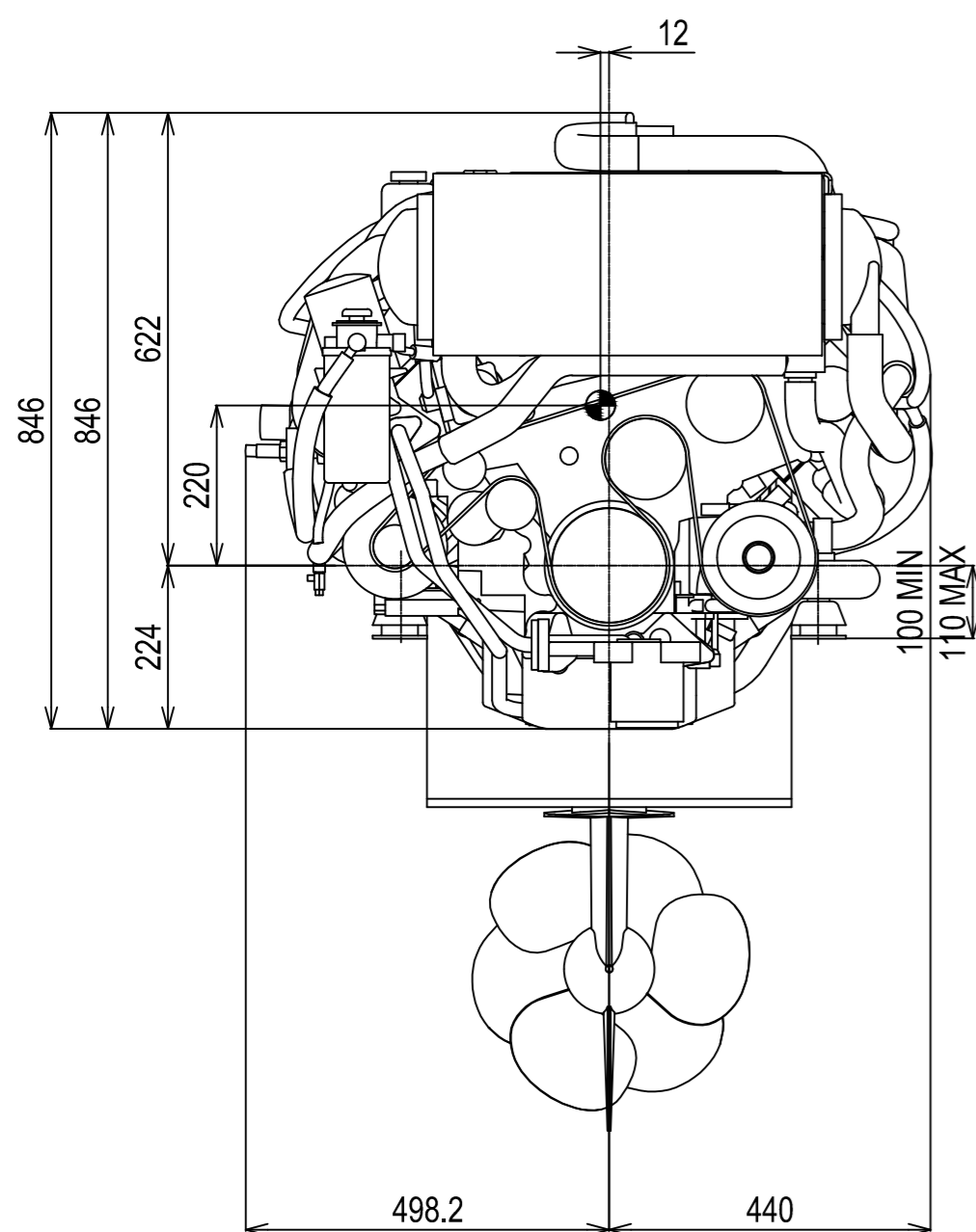
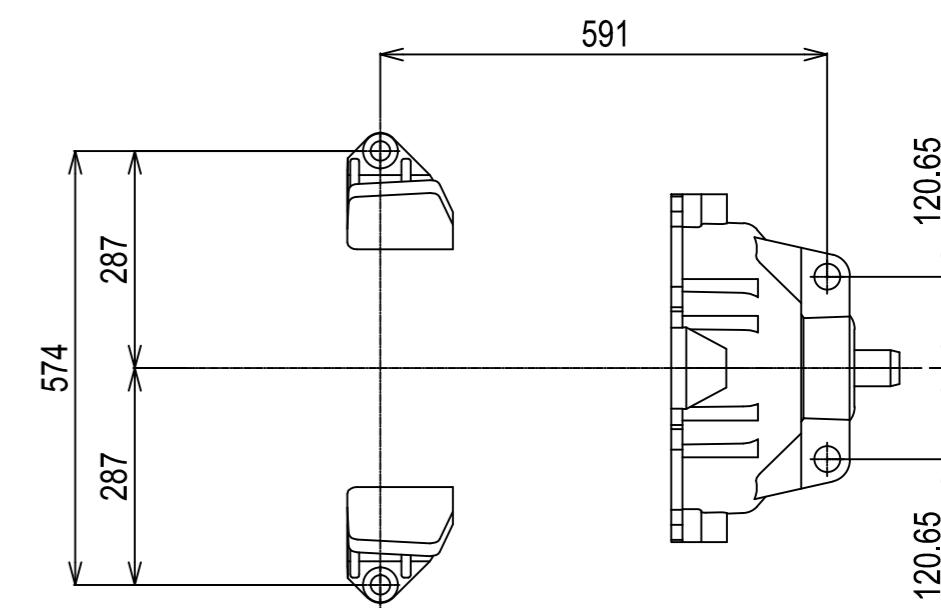
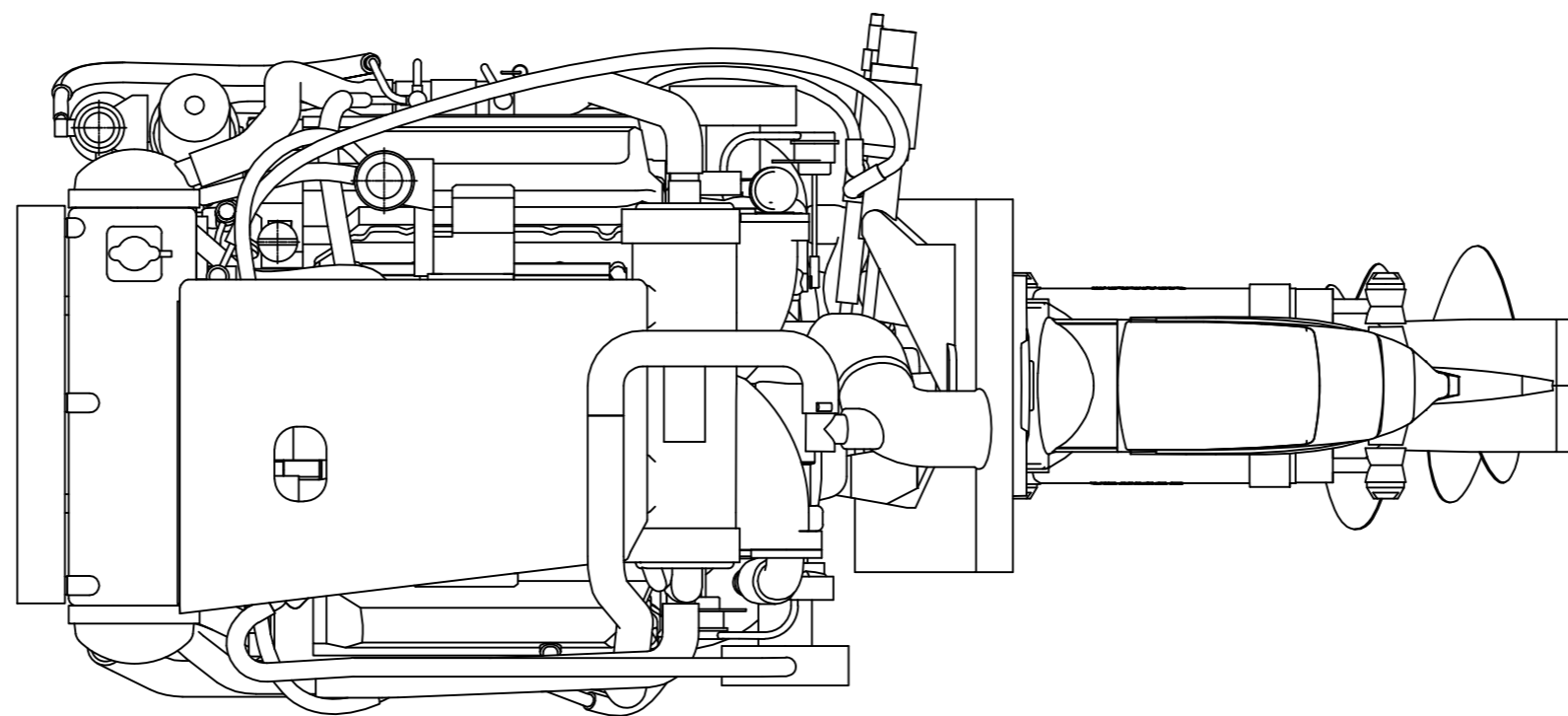
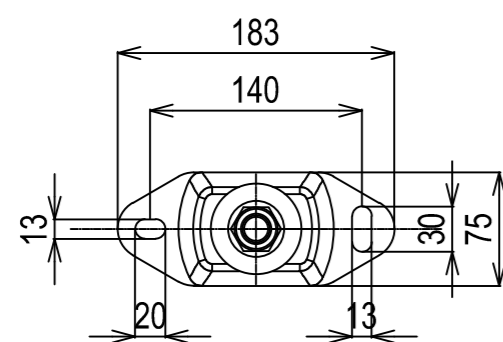

**NOTE:**

- 1.DWG.SHOWS MOUNTING BLOCKS AT ORIGINAL HEIGHT.  
ENGINE WEIGHT WILL COMPRESS BLOCKS BY 3 MM(APPROX).
- 2.MOUNTING BLOCKS ARE EQUIPPED FOR STANDARD ACCESSORY.
- 3.● SHOWS THE CENTER OF GRAVITY.
- 4.FOR ADDITIONAL INSTALLATION INFORMATION AND SPECIFICATIONS  
PLEASE REFER TO THE YANMAR ENGINE INSTALLATION MANUAL

Engine:	8LV370Z_ZT370 with Hight Riser	Release:	31-08-2010
Scale:	1:10	Date:	01-04-2014
		Dimensions:	mm

