

DETAIL OF FLYWHEEL

DIRECTION OF ROTATION

DETAIL OF MOUNTING BLOCK

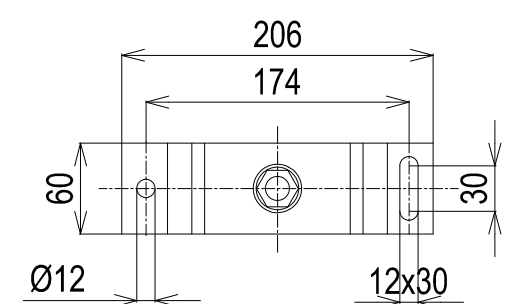
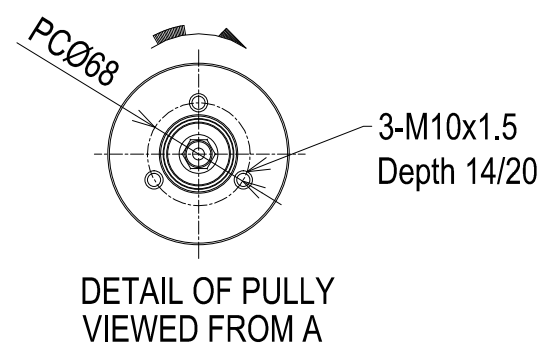
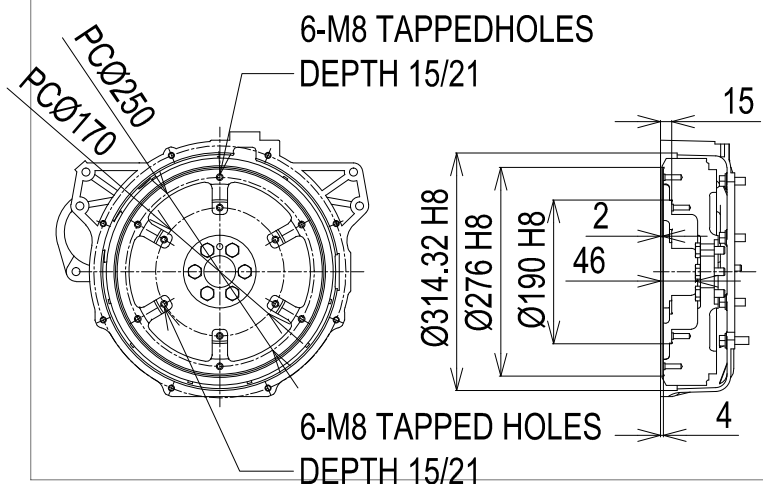

NOTE:

1. DWG. SHOWS MOUNTING BLOCKS AT ORIGINAL HEIGHT. ENGINE WEIGHT WILL COMPRESS BLOCKS BY 4MM (APPROX).
2. MOUNTING BLOCKS ARE EQUIPPED FOR STANDARD ACCESSORY.
3. ● SHOWS THE CENTER OF GRAVITY.
4. THE FIGURES MARKED WITH * SHOW THE DIMENSIONS WITH U-MIXING ELBOW, OR OPTIONAL COUPLING.
5. FOR ADDITIONAL INSTALLATION INFORMATION AND SPECIFICATIONS PLEASE REFER TO THE YANMAR ENGINE INSTALLATION MANUAL

Engine:	4JH5E_BOBTAIL	Release:	02-07-2008
Scale:	1:10	Date:	01-04-2013
		Dimensions:	mm

