



**YANMAR**

# B95W

COMPACT WHEELED EXCAVATOR



**Operating weight**

9 100 – 9 500 kg

**Engine**

Deutz TCD 3.6 L4 EU Stage V

**Engine power**

74,4 kW (101 HP)

**Travel speed**

0-36 km/h

**Breakout force**

53,2 kN

**Digging force**

42,6 kN

**Dig depth**

4 080 mm



B95W

# THE BEST PARTNER OF YOUR SUCCESS







## HIGH PERFORMANCE

The B95W is very efficient and can perform tasks reserved for machines with higher weight. Thanks to its enormous lifting capacities and its precise hydraulic system, this 9 tons is capable of transporting and positioning particularly heavy loads on construction sites. This machine has great advantages for the logistics of materials and is therefore very interesting in construction and especially for the road construction. Equipped with a grab bucket, it allows in horticulture to catch and to load trucks.



## STATE-OF-THE-ART ENGINE

Powered by a four-cylinder turbocharged Stage V-compliant diesel engine, fitted with DPF and charge cooler as standard, the B95W sets the standards in fuel efficiency and environmentally friendly operation. Common rail technology and direct injection functionality maximizes performance, providing total control for the operator.



## UNIQUE 'SMART CONTROL'

The B95W is fitted with Yanmar's Smart Control operating system as standard, which enables the operator to match excavator power with precise jobsite application. This flexibility maximizes productivity, optimizes cycle times and guarantees outstanding performance.



## EASY OPERATION

Thanks to the adoption of intuitive operator technologies, such as multi-functional joysticks, fingertip operation and Smart Control, the B95W is easy and enjoyable to operate – the perfect combination for a highly productive workday.



## EASY MAINTENANCE

Clever design, large service doors and easy access to the engine bay means that daily maintenance checks can be delivered simply and safely from ground-level.



## SPACIOUS AND COMFORTABLE CABIN

Spacious, comfortable and quiet, the B95W cab has been designed with the operator firmly in mind. Ergonomic control arrangement, class-leading visibility and clear display screens provide the perfect environment for safe and efficient operation.



## RELIABLE POWERLINE

Thanks to reliable, heavy-duty components, operators no longer have to choose between power and compactness. Difficult tasks can be completed easily – even in the tightest of spaces!



## VERSATILE AND FLEXIBLE

The B95W can be tailored with a wide variety of options and attachments to ensure perfect suitability for exacting applications. From construction and landscaping, to pipelaying and highway maintenance, there's a setup for almost every task.



# POWER, PERFORMANCE AND PRODUCTIVITY



The B95W is the perfect combination of power and precision, adopting next-generation technology to maximize performance and minimize environmental impact. Versatile, flexible and designed with the operator in mind, it promises to deliver over and above all expectations – regardless of application.

## TAKE ADVANTAGE OF THE NEW ENGINE TECHNOLOGY

The B95W adopts a highly efficient diesel engine, which delivers impressive power and performance while meeting EU Stage V emissions regulations. Achieving a significant reduction in particulate emissions, the engine has a low environmental impact.

### LOW EMISSIONS, HIGH FUEL ECONOMY

The EU Stage V engine delivers unmatched performance and achieves impressive fuel economy

- + Fitted with a Diesel Particulate Filter (DPF) as standard, operators benefit from lower servicing costs.
- + Enhanced exhaust after-treatment, comprising improved combustion/injection systems and a Diesel Oxidation Catalyst (DOC) reduce emissions pollutants by up to 90%.
- + The Selective Catalytic Reduction (SCR) module ensures that the correct amount and proportions of AdBlue solution are injected to break down NOx into water and non-toxic nitrogen.







### HYDROSTATIC TRANSMISSION

High-pressure hydrostatic transmission ensures maximum productivity thanks to hydrostatic drive technology - offering smooth power delivery without unnecessary traction interruption.

### WORKING HYDRAULICS

Thanks to the four independent hydraulic circuits, the B95W wheel excavator increases its capacity with attachment tools. The driver

can operate a tilt rotator with a hydraulic quick-hitch system and hydraulically-driven tool, such as a sorting grab, an asphalt cutter or cutting unit, for example. The control circuits can be operated at the same time, they do not influence each other.

Standard is also the possibility to switch off the bucket cylinder and provide this oil flow at a hydraulic quick coupling at the arm end. That means full flexibility and power for whatever attachment you want to use.



## CLASS-LEADING STABILITY

Thanks to its unique axle design (with 11,5° pendulum angle), minimum tail swing, laterally installed engine and low center of gravity, operators are guaranteed class-leading stability (especially for craning work) - even with the boom fully extended.

- + Its class leading stability is exceptional for a machine in that size class and can even be improved by the choice of optional tires or additional counterweight.
- + All cylinders have end position damping for low-vibration working.



# COMPACTNESS



## TWO-PIECE BOOM OPTIONS FOR A REDUCED SWING RADIUS

The B95W is fitted with a two-piece articulated boom as standard, which offers excellent maneuverability and impressive articulation.

Operators can even bring the bucket back against the chassis or blade – ideal for avoiding obstacles.

An optional longer dipperstick (2 200 mm) further extends excavation radius.





# SPEED AND MOBILITY



With a top speed of 36km/h, variable drive system, low fuel consumption and comfortable cab, travel from one site to another is effortless. This alleviates the requirement for costly logistics solutions and maximizes operator uptime.

- + Hydrostatic travel drive, which is independent of the working hydraulics, can function as an additional braking system when travelling between jobsites.
- + A top speed of 36km/h allows fast and effective roading.
- + Automatic drive function, alongside an additional accelerator pedal for delicate machine movements, provides total flexibility for the operator.

# ALL-TERRAIN ABILITY

Thanks to innovative design and a class-leading ground clearance (320mm), the B95W is suitable for every terrain.

## THREE STEERING MODES

The B95W can be fitted with Yanmar's all-wheel steering system as an optional extra. Through the in-cab Smart Control panel, operators can select:

- 1 Front-wheel steering (perfect for roading)
- 2 All-wheel steering (providing a small turning circle for tight job sites)
- 3 Crab steering (for parallel movement)

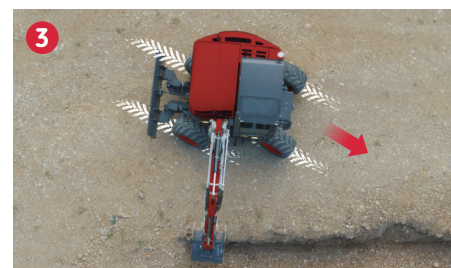
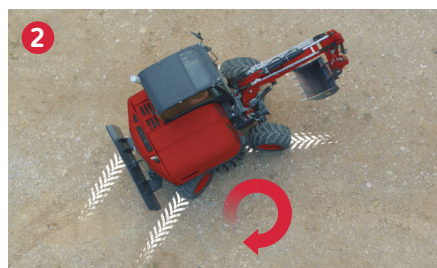
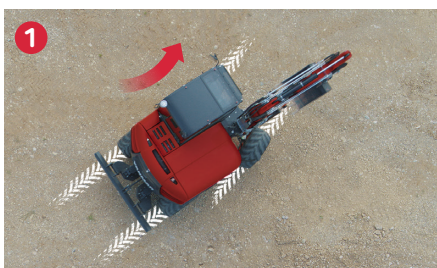

## A WIDE CHOICE OF TIRES

Depending on application, the B95W can be equipped with a selection of different tires to suit the needs of the operator - single, low-pressure, twin or wide.



# COMFORT

## SPACIOUS CAB

Spacious and comfortable, the B95W cab has been designed with the operator firmly in mind. The seat console is fully-adjustable, moves independently and provides the perfect working environment.

## ERGONOMIC DESIGN

Providing the operator with comprehensive system information briefly, the central data display is clear, easy to navigate and has been designed to reflect the tiled layout of a smart phone. The 7" anti-reflective screen is well-designed, perfectly positioned and is also used as a monitor for the B95W's reversing camera.

## LARGE KEYPAD

The keypad incorporates an extra-wide pressure surface to make operation easy - even when wearing gloves!



# EASE OF USE

## SMART CONTROL OPERATING SYSTEM

As with all models in Yanmar's wheeled excavator range, the B95W benefits from next-generation Smart Control operating technology. The proprietary system allows fast and intuitive machine control, alongside improved monitoring capabilities. Key features include:

- + Large, clear display for live data monitoring
- + Intuitive and ergonomic controls
- + Full control of the first, second and third hydraulic circuits
- + Customizable settings to suit driver requirements

## FINGERTIP CONTROL

Precise fingertip control capability allows the operator to monitor oil flow (from zero to full). A thumbwheel on the joystick provides a quick and simple way to switch between hydraulic functions.

## CUSTOMISABLE CONTROLS

The B95W is fitted with ISO controls as standard, but SAE controls can be specified as an optional extra. The pattern changeover can be easily selected and activated via the LCD display screen.



# SAFETY-CRITICAL FEATURES

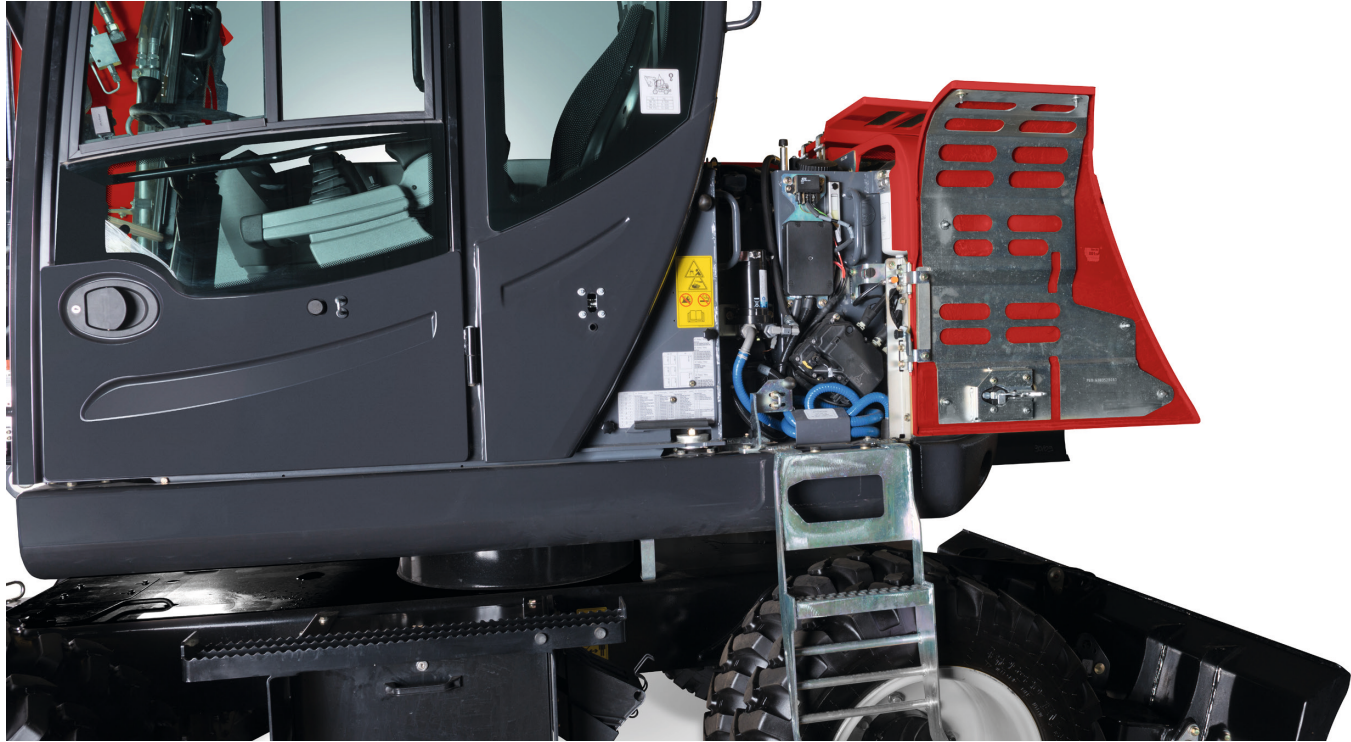

## REAR VIEW CAMERA

The B95W is equipped with a state-of-the-art rear-view camera as standard, which can be configured to suit precise operator preferences. This improves visibility from the cab, thus maximizing on-site safety by preventing the risk of collisions.

## AUTOMATIC REFUELLING PUMP

Available as an added extra, operators can specify an all-new automatic refueling pump, which is equipped with a level sensor that stops the pump when the fuel tank is full. This enables refueling at the touch of a button – quick, safe and simple.

# MANAGEABLE MAINTENANCE

Service requirements have been considered throughout the B95W's design. As such, a service bar containing the central electrics has been integrated into the main service compartment. This makes accessing relays and fuses simple and achievable from ground-level.

The service door can be opened without tools and integrates an extending ladder (protected by rubber buffers). There are no main hydraulic components located under the cab, which means tilting is not required.

Thanks to Yanmar's SmartAssist-Direct diagnosis tool, maintenance information and requirements are automatically transmitted to the engineer. This minimizes diagnosis requirements and provides comprehensive insight into parts replacement requirements, operation history, troubleshooting and fault diagnostics.



## SMARTASSIST REMOTE

SmartAssist Remote is Yanmar's next-generation fleet management system. Harnessing the latest telematics technology, equipment location and status is reported in real time. This provides total control and allows fleet managers to manage their assets remotely (via a PC or smartphone).



# TAILORED TO YOU

The B95W comes with several features as standard, while also having the possibility to be configured to meet the specialist requirements of various customers; such as landscapers, civil contractors, utility professionals and municipal authorities. From the color scheme to the choice of boom, blade or tires, as well as the buckets and hydraulic attachments, the B95W can be perfectly tailored to match the needs of your business.



## BOOM OPTIONS

A range of boom options are available to suit precise operator applications:

- + TPA boom, with standard dipperstick 2 000 mm and long dipperstick 2 200 mm
- + Circular boom, with dipperstick 1 650 mm
- + Monobloc boom, offset boom 850 mm, with dipperstick 2 000 mm

## STEERING MODES

The B95W has three steering modes to suit a wide range of applications, which can be changed easily thanks to the integration of Smart Control:

- + Front-wheel steering for fast roading
- + All-wheel steering for tight turning circles
- + Crab steering for parallel travel

## STABILITY

To maximize stability, particularly during heavy excavation work or when travelling on rough terrain, the B75W can be equipped with a wide range of optional extras:

- + Front dozer blade
- + Stabilizers
- + Support blade

## LEVELLING

The optional float function of the dozer blade makes ground levelling, filling and debris removal simple.

## TIRE OPTIONS

- + Single tire 500/45-20Alliance
- + Single tire 500/45-20Mitas
- + 315/70R22.5 Bandenmarkt tire tread Delcora SGX-1
- + 275/70 R22.5 Bandenmarkt Profil Excavator

## ATTACHMENTS

To maximise productivity, Yanmar offers a wide range of attachments for construction, pipe laying, civil engineering, landscaping and agricultural applications. Thanks to its unique hydraulic system and auxiliary circuits, operating and changing attachments can be actioned at the touch of a button.

## KEY ATTACHMENTS INCLUDE

- |                                 |                         |                         |                |
|---------------------------------|-------------------------|-------------------------|----------------|
| + Mechanical quick-hitch system | + Powertilt             | + Standard bucket       | + Breakers     |
| + Hydraulic quick-hitch system  | + Tiltrotators          | + Ditch-cleaning bucket | + Pallet forks |
|                                 | + Light-material bucket | + Swing bucket          |                |





# LIFTING CAPACITY



Blade down



Blade up

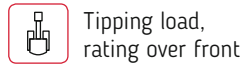

Tipping load, rating over front

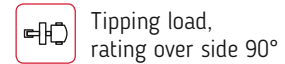

Tipping load, rating over side 90°

TPA BOOM with dipperstick 2 000 mm

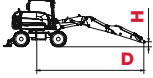

H		D									
		3 m		4 m		5 m		6 m		7 m.	
3,0 m		--	--	2,6	2,3	1,7	1,6	1,5	1,0	--	--
		--	--	2,2	2,2	1,6	1,6	1,0	1,0	--	--
1,5 m		4,1	3,5	2,6	2,3	2,1	1,6	1,5	1,0	--	--
		3,4	3,3	2,2	2,2	1,3	1,5	0,9	1,0	--	--
0,0 m		4,5	2,7	2,7	1,8	2	1,3	1,5	0,9	--	--
		2,6	2,6	1,7	1,7	1,2	1,2	0,9	0,9	--	--
-1,0 m		4,7	2,7	2,9	1,7	2	1,2	--	--	--	--
		2,6	2,6	1,6	1,7	1,2	1,2	--	--	--	--

TPA BOOM with dipperstick 2 000 mm, additional counterweight

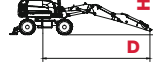

H		D									
		3 m		4 m		5 m		6 m		Max.	
3,0 m		--	--	2,6	2,4	1,8	1,7	1,5	1,1	--	--
		--	--	2,4	2,3	1,7	1,7	1,1	1,1	--	--
1,5 m		4,2	3,7	2,6	2,3	2,1	1,7	1,6	1,1	--	--
		3,6	3,7	2,3	2,3	1,7	1,6	1,1	1,1	--	--
0,0 m		4,7	2,9	2,8	1,9	2,1	1,4	1,6	1,0	--	--
		2,8	2,9	1,8	1,9	1,3	1,4	1,0	1,0	--	--
-1,0 m		4,8	2,9	3,0	1,9	2,1	1,4	--	--	--	--
		2,8	2,8	1,8	1,9	1,3	1,4	--	--	--	--

TPA BOOM with dipperstick 2 200 mm

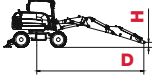

H		D									
		3 m		4 m		5 m		6 m		Max.	
3,0 m		--	--	2,4	2,0	1,8	1,7	1,4	1,1	1,4	0,9
		--	--	2,1	1,9	1,5	1,6	0,9	1,0	0,8	0,8
1,5 m		4,2	3,5	2,6	2,3	1,6	1,6	1,5	1,0	1,3	0,8
		3,1	3,3	2,1	2,2	1,5	1,6	0,9	1,0	0,7	0,8
0,0 m		4,5	2,8	2,8	1,8	2,1	1,3	1,6	1,0	1,2	0,8
		2,5	2,6	1,6	1,7	1,2	1,2	0,9	0,9	0,7	0,8
-1,0 m		4,8	2,7	3	1,8	2,2	1,3	1,3	1	1,1	1,1
		2,5	2,6	1,6	1,7	1,2	1,2	0,9	0,9	0,8	0,9

TPA BOOM with dipperstick 2 200 mm, additional counterweight

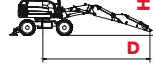

H		D									
		3 m		4 m		5 m		6 m		Max.	
3,0 m		--	--	2,4	2,4	1,8	1,8	1,9	1,2	--	--
		--	--	2,2	2,4	1,7	1,8	1,1	1,1	--	--
1,5 m		4,2	3,9	2,6	2,5	2,2	1,8	2,0	1,2	--	--
		3,5	3,7	2,3	2,5	1,7	1,7	1,1	1,1	--	--
0,0 m		4,3	3,1	2,6	2,1	2,0	1,5	1,6	1,1	--	--
		2,9	3,0	1,9	2,0	1,4	1,4	1,0	1,1	--	--
-1,0 m		4,6	2,9	2,9	1,9	2,1	1,5	1,2	1,3	--	--
		2,8	2,9	1,9	1,9	1,4	1,4	1,1	1,3	--	--

Circular Boom

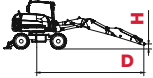

H		D									
		3 m		4 m		5 m		6 m		Max.	
3,0 m		4,4	3,8	2,5	2,5	1,7	1,7	1,7	1,0	1,3	0,8
		3,3	3,6	2,2	2,3	1,3	1,6	0,9	1,1	0,7	0,7
1,5 m		4,8	3,1	2,8	2	2,1	1,4	1,6	1,0	0,8	0,8
		2,7	2,9	1,8	1,9	1,2	1,3	0,9	0,9	0,6	0,7
0,0 m		5,3	2,7	3,3	1,8	2,2	1,3	1,5	1,0	0,5	0,6
		2,3	2,4	1,5	1,7	1,1	1,2	0,8	0,9	0,5	0,6
-1,0 m		4,4	2,6	2,9	1,8	1,6	1,3	1,1	1,1	0,3	0,4
		2,3	2,4	1,5	1,6	1,1	1,2	0,9	0,9	0,3	0,4

Circular Boom, additional counterweight

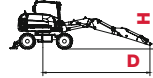

H		D									
		3 m		4 m		5 m		6 m		Max.	
3,0 m		4,2	4,1	2,5	2,7	1,7	1,6	1,7	1,1	1,3	0,9
		3,7	3,9	2,4	2,5	1,6	1,6	1,0	1,1	0,8	0,8
1,5 m		4,8	3,3	2,6	2,1	2,1	1,5	1,7	1,1	0,9	0,6
		2,9	3,1	1,9	2,1	1,4	1,5	1,0	1,1	0,7	0,6
0,0 m		5,1	2,8	3,2	1,9	2,2	1,4	1,5	1,0	0,4	0,4
		2,5	2,7	1,7	1,8	1,3	1,3	0,9	1,0	0,4	0,4
-1,0 m		4,3	2,8	2,8	1,8	1,9	1,4	1	1,2	0,3	0,3
		2,4	2,7	1,7	1,8	1,2	1,3	1	1,1	0,3	0,3

Monobloc offset boom



H		D									
		3 m		4 m		5 m		6 m		Max.	
3,0 m		--	--	--	--	--	--	1,7	1,1	1,9	0,9
		--	--	--	--	--	--	0,9	1,0	0,7	0,8
1,5 m		--	--	4,4	1,9	3,0	1,3	2,3	1,0	1,8	0,8
		--	--	1,6	1,8	1,1	1,2	0,9	0,9	0,7	0,7
0,0 m		--	--	5,3	1,7	3,2	1,3	2,3	0,9	1,7	0,8
		--	--	1,4	1,5	1,1	1,2	0,8	0,9	0,7	0,6
-1,0 m		--	2,4	4,4	1,6	2,8	1,2	1,9	0,9	1,6	0,8
		2,2	2,3	1,4	1,5	1,1	1,1	0,8	0,9	0,8	0,8

Monobloc offset boom, additional counterweight



H		D									
		3 m		4 m		5 m		6 m		Max.	
3,0 m		--	--	--	--	--	--	1,9	1,1	1,9	1,0
		--	--	--	--	--	--	1,0	1,1	0,8	0,9
1,5 m		--	--	4,4	2,0	2,9	1,5	2,3	1,1	1,8	0,9
		--	--	1,8	1,9	1,3	1,4	1,0	0,8	0,8	0,8
0,0 m		--	--	5,3	1,9	3,2	1,3	2,3	1,1	1,7	0,9
		--	--	1,7	1,7	1,2	1,3	0,9	1,0	0,8	0,8
-1,0 m		--	2,9	4,3	1,8	2,8	1,4	1,9	1,1	1,6	1,0
		2,4	2,5	1,6	1,7	1,2	1,3	0,9	1,0	0,9	0,9

[ All values specified in tons (t) were determined in compliance with ISO 10567 and include a stability factor of 1,33 or 87% of the hydraulic lifting capacity. All values were determined with quick-mount hitch but without bucket. In case of mounted-on work attachments, the deadweights of the work attachments must be deducted from the permissible payloads. ]



# DIMENSIONS

## TPA BOOM

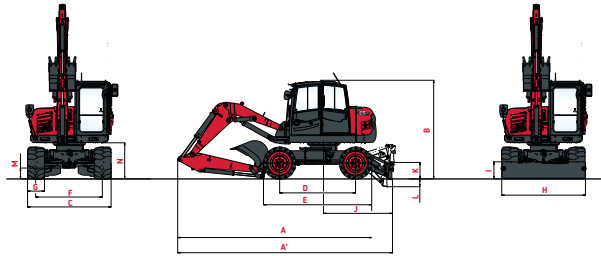

## CIRCULAR BOOM

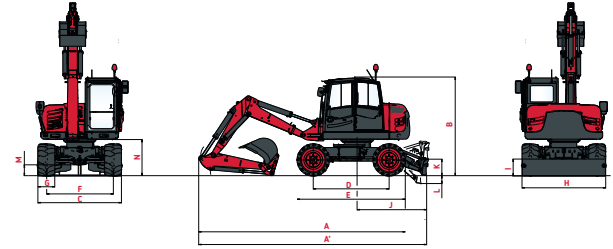

## MONOBLOC BOOM

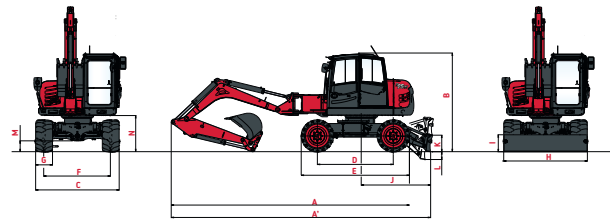

	TPA Boom	Circular Boom	Monobloc Boom		TPA Boom	Circular Boom	Monobloc Boom
<b>A</b> Overall length	5 700 mm	6 070 mm	7 000 mm	<b>H</b> Overall blade width	2 460 mm	2 460 mm	2 460 mm
<b>A'</b> Overall length with blade at the back	6 320 mm	6 700 mm	7 630 mm	<b>I</b> Overall blade height	500 mm	500 mm	500 mm
<b>B</b> Overall height	2 900 mm	2 900 mm	2 900 mm	<b>J</b> Blade distance	2 030 mm	2 030 mm	2 030 mm
<b>C</b> Overall width	2 460 mm	2 460 mm	2 460 mm	<b>K</b> Max. blade height above the ground	485 mm	485 mm	485 mm
<b>D</b> Wheel base	2 240 mm	2 240 mm	2 240 mm	<b>L</b> Max. blade depth	230 mm	230 mm	230 mm
<b>E</b> Undercarriage length	3 180 mm	3 180 mm	3 180 mm	<b>M</b> Minimum ground clearance	320 mm	320 mm	320 mm
<b>F</b> Lane	1 960 mm	1 960 mm	1 960 mm	<b>N</b> Ground clearance under counterweight	1 060 mm	1 060 mm	1 060 mm
<b>G</b> Tire width	496 mm	496 mm	496 mm				

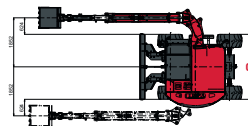
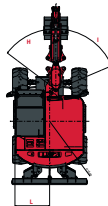
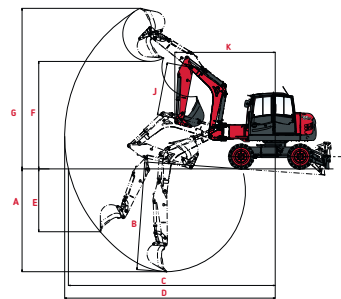
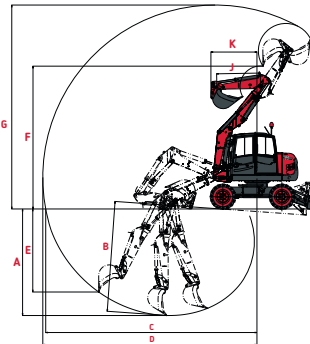
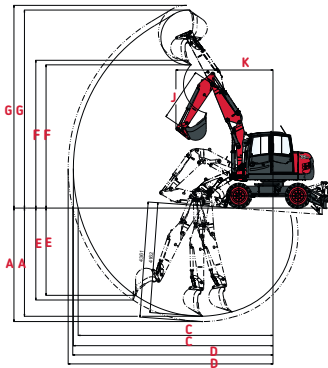

	TPA Boom	Circular Boom	Monobloc Boom		TPA Boom	Circular Boom	Monobloc Boom
<b>A</b> Max. digging depth - Blade lifted	4 100/*4 300 mm	4 030 mm	3 890 mm	<b>G</b> Max. cutting height	7 500/*7 660 mm	7 700 mm	6 070 mm
<b>B</b> Max. digging depth - Blade lowered	4 160/*4 360 mm	4 160 mm	4 080 mm	<b>H</b> Boom swinging base to left	53°	53°	53°
<b>C</b> Max. digging reach on ground	7 370/*7 550 mm	7 990 mm	7 820 mm	<b>I</b> Boom swinging base to right	67°	67°	67°
<b>D</b> Max. digging reach	7 570/*7 740 mm	8 100 mm	7 960 mm	<b>J</b> Arm length	2 000/*2 200 mm	1 650 mm	2 000 mm
<b>E</b> Max vertical wall	3 300/*3 470 mm	3 140 mm	2 980 mm	<b>K</b> Front turning radius	3 670 mm	1 740 mm	3 790 mm
<b>F</b> Max. dumping height	5 410/*5 580 mm	5 400 mm	4 060 mm	<b>L</b> Rear turning radius	1 550 mm	1 550 mm	1 550 mm

\*TPA Boom with dipperstick 2 200 mm.



# SPECIFICATIONS

## [ OPERATING ]

Operating weight (monobloc / TPA / circular boom) acc. to ISO 6016	9100 kg / 9300 kg / 9500 kg
Total length, travel position (monobloc / TPA / circular boom)	5700 mm / 5560 mm / 5440 mm
Total height (travel position)	3950 mm
Transport dimensions: Monobloc / TPA / Circular boom (L x H)	6520 x 2930 mm / 6300 x 2930 mm / 6720 x 2930 mm
Total width (twin tires)	2450 mm
Total height (top of cab)	2930 mm
Tread width	1942 mm
Wheelbase	2240 mm
Ground clearance below cardan shaft	400 mm
Turning radius	6700 mm
Rear swing radius	1550 mm
Uppercarriage frontswing (monobloc / TPA / circular boom)	2960 mm
Working envelope 180°	4510 mm
Working envelope 360°	6090 mm / 5920 mm / 3340 mm

## [ ENGINE ]

Manufacturer, model	Deutz TCD 3.6 L4 Stage V
Type	Turbo diesel engine with intercooler - EU Stage V / Tier 4 final
Combustion	4-stroke cycle, Common Rail injection
Displacement	3600 cm <sup>3</sup>
Power rating acc. to ISO 9249 at 2000 rpm	74,4 kW (101 HP)
Torque	410 Nm at 1600 rpm-1
Cooling system	Water

## [ ELECTRICAL SYSTEM ]

Nominal voltage	12 V
Battery	12 V / 135 Ah
Generator	14 V / 95 Ah
Starter	12 V / 4,0 kW

## [ HYDRAULIC SYSTEM ]

Hydrostatic travel drive in closed circuit with automatic adjustment of drawbar pull and speed independent of the working hydraulics.

Pump capacity, max.	2,2 / 4,0 km/h
Working pressure, max.	9,1 rpm

Working hydraulics: Axial-piston variable displacement pump with load sensing, coupled with a load independent flow sharing (LUDV). Simultaneous, independent control of all movements. Sensitive maneuvers irrespective of loads.

Max. pump capacity	max. 142 l/min
Working pressure, max.	max. 280 bar

The thermostatically controlled oil circuit ensures that the oil temperature is promptly reached and avoids overheating. Hydraulically actuated reversible fan. Return filter installed in oil tank allows for eco-friendly replacement of filter elements.

Triple gear pump for all positioning movements, pivoting of upper carriage and for hydrostatic fan.

Hydraulic flow, max.	38 + 38 + 38 l/min
Working pressure, max.	250 bar

Control circuit for work attachments, proportionally operated. Pump capacity, adjustable 0 – 100 l/min.

Working pressure, max.	280 bar
------------------------	---------

## [ TRANSMISSION ]

4-wheel drive from reduction gear on front axle via cardan shaft to rear axle. Infinitely variable speed control forward and reverse.

2 speed ranges	"Low" 0-6 km/h "High" 0-20 km/h
4 speed ranges (high-speed version optional)	"Low" 0-5 / 0-15 km/h "High" 0-11 / 0-36 km/h

## [ MAINTENANCE FREQUENCY ]

Change engine oil and filter: 500h or minimum once a year | Change fuel filter: 1000h or minimum once a year | Change hydraulic oil filter: 100 + 500h ; every 1000h or minimum every 2 years | Change hydraulic oil filter: first after 100h, then follow the instructions at display | Change cooling fluid: if needed or minimum every 2 years.



# STANDARD EQUIPMENTS

## [ CABIN ]

Spacious, sound-insulated full-vision steel cab (ROPS certified).	
Sliding window in cab door.	
Safety glass windows, thermo windows tinted in green.	
Skylight thermo window, bronze tinted.	
Panoramic rear window.	
Front window supported by pneumatic springs, slidable under cab roof.	
Ventilation position by tilting the front window. Windshield washer system.	
Storage compartment. Preparation for radio installation. Left-hand outside rear-view mirror.	
Cab heating with front window defroster by coolant heat exchanger with stepless fan.	
Fresh air and recirculating air filters.	
Operator's seat MSG 85 (comfort version), hydraulic damping, extra-high backrest, tilt-adjustable armrests, longitudinal-horizontal suspension, mechanical lumbar support. Lap belt.	
Rear view camera Instrument panel on the right-hand side of the operator's seat with visual & acoustic warning device, hour-meter and safety module.	
Working floodlights LED.	
Effective values of acceleration for whole body less than 0.5 m/s <sup>2</sup> .	
Effective values of acceleration for hand-arm less than 2.5 m/s <sup>2</sup> .	
Vibration values in compliance with Directive 2006/42/EC and EN474.	
Sound level	Sound power level (LWA) around the machine 100 dB (A) Sound pressure level (LpA) in cab 72 dB (A) Sound level values measured in compliance with Directive 2000/14/EC and EN474

## [ AXLES ]

Front: Oscillating planetary drive axle, oscillating angle	11,5°
Rear: Rigid planetary drive axle.	

## [ STEERING ]

Fully hydraulically controlled front axle with integrated steering cylinder.	
Max. steering angle	32°

## [ SWING SYSTEM ]

Hydrostatic drive with 2-stage planetary gear and axial piston fixed displacement motor, also acts as wear-resistant brake. In addition, spring-loaded multi-disc brake acting as parking brake.

Swing speed	0-10 rpm
-------------	----------

## [ KNICKMATIK® ]

Lateral parallel adjustment of boom arrangement at full dig depth.

Parking brake: Hydraulic spring-loaded brake, electrically actuated	53° / 960 mm
Parking brake: Hydraulic spring-loaded brake, electrically actuated	68° / 900 mm

## [ TIRES ]

Standard 8.25-20, 14 PR twin tires.
-------------------------------------

## [ FLUID CAPACITIES ]

Fuel tank	160 l
AdBlue tank	10 l
Hydraulic system (incl. tank)	175 l

## [ BRAKES ]

Service brake: Hydraulic pump accumulator two-circuit brake, acting on oil-immersed multi-disc brakes of front and rear axle.

Excavator brake: Acting on front and rear axle due to lockable service brake.

Auxiliary brake: Hydrostatic travel drive in closed circuit acting as non-wearing auxiliary brake.

Parking brake: Hydraulic spring-loaded brake, electrically actuated.



# OPTIONAL EQUIPMENTS

## PERFORMANCE

Diesel Particulate Filter (DPF) | Auto-idle system | Travel drive, standard steering 25 km/h | Travel drive, all-wheel steering 20 km/h | Travel drive, all-wheel steering 25 km/h | Travel drive, fast 30 km/h | Travel drive, all-wheel steering 36 km/h | TPA boom, with dipperstick 2200 mm | Circular boom, with dipperstick 1650 mm | Monobloc boom, off set boom 850 mm, with dipperstick 2000 mm | Front dozer blade, 2460 mm wide (twin tires) or 2290 mm wide (single tires) | Steering change-over in case of blade operation | Rear support blade, 2460 mm wide (with twin and wide tires) | Rear support blade, 2290 mm wide (with single tires) | Float position front dozer blade | Rear outrigger plates, rubber-coated, oscillating | Cover for support cylinders | Additional counterweight (+365 kg) | Proportionnal 4th circuit, control on left joystick | Proportional 4th hydraulic circuit line + Powertilt line, control on left joystick | Hydraulic installation for quick-attach system | Biodegradable hydraulic oil | Provision of hydraulic oil, oil approval by Yanmar required | Special tires: 500/45-20 (single wide tires) 500/45-20 Mitas (Single tires) | 275/70 R22.5 Bandenmarkt, tire tread «Excavator» (Twin Tires) | 315/70R22.5 Bandenmarkt tire tread Delcora SGX-1 (Single tires).

## COMFORT & EASE OF USE

Operator's seat MSG 95 (premium version), air damping, extra-high backrest and tilt-adjustable armrests, longitudinal-horizontal suspension, seat and backrest heating, pneumatic lumbar support | Sliding window on right-hand side | A/B control pattern switch | Air-conditioning | Engine-independent diesel heater with fresh air circulation and timer | Outside rear-view mirror, heatable | Electric refuelling pump with automatic switch off | Coolbox | Toolbox and toolkit | Grease pump.

## SAFETY & DURABILITY

FOPS protective grid for skylight guard | Guard for front window | Supplementary set hose-rupture/load-retaining valves for TPA boom, bucket cylinder | Fire extinguisher, ABC powder, 2 kg, mounted in the cab | Anti-theft device, coded | Electronic anti-theft device | Travel alarm | Automatic engine shutdown | LED Lighting package | Boom-mounted LED working light | LED yellow attachable rotating beacon.

## [ ATTACHMENTS ]

We offer a range of factory fitted attachments to maximize the versatility of your wheeled excavator. Yanmar offers selected mechanical and hydraulic quick couplers, powertilt, digging buckets, ditch cleaning buckets, rippers and breakers.





**YANMAR**



Yanmar Compact Equipment EMEA

GB\_B95W\_0921



[www.yanmar.com](http://www.yanmar.com)